

Single-lever mixer Pull-down with spray function

33 875 895



- 240 mm projection
- pivotable spout 360°
- laminar and spray flow
- height of mixer 420 mm
- height up to laminar flow regulator 240 mm
- hole diameter 35 mm
- 1800 mm metal shower hose
- sprayface with anti-scaling system
- max. flow 10.4 l/min at 3 bar flow pressure
- lead-free
- This product can help a building to meet requirements of Green Building Rating Systems, e.g. LEED®, BREEAM®, DGNB

Intrinsic protection against back flow.

	Chrome	33 875 895-00
	Brushed Platinum	33 875 895-06
	Platinum	33 875 895-08
	Durabrand (23kt Gold)	33 875 895-09
	Dark Chrome	33 875 895-19
	Brushed Durabrand (23kt Gold)	33 875 895-28
	Matte Black	33 875 895-33
	Brushed Champagne (22kt Gold)	33 875 895-46
	Champagne (22kt Gold)	33 875 895-47
	Brushed Chrome	33 875 895-93
	Brushed Dark Platinum	33 875 895-99

Recommended miscellaneous

Swivel limitation set 12 821 970 90



Recommended miscellaneous

Strainer waste with control handle 10 712 970-00



Recommended miscellaneous

Dispenser without rosette 82 424 970-00



Single-lever mixer Pull-down with spray function

33 875 895

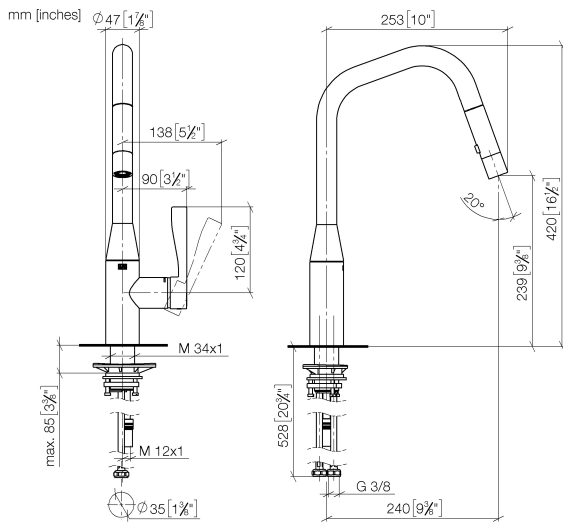

Flow rate chart

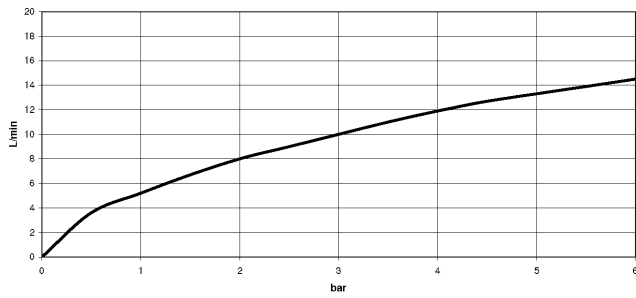

Single-lever mixer Pull-down with spray function

33 875 895

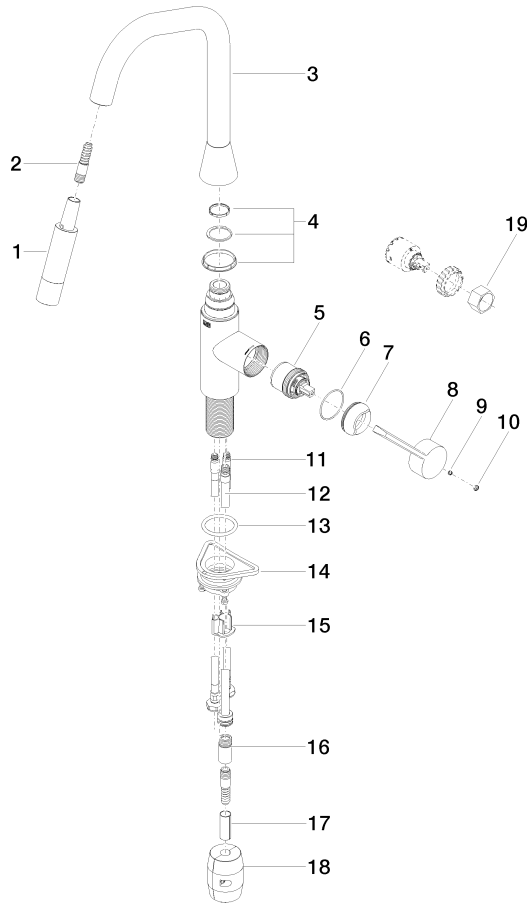

Spare parts list

No.	Item Number	Name	Quantity used	Delivery time
1	04 12 11 148 00-00	shower	1	10
2	04 30 02 120 00-00	hose	1	10
3	90 28 22 301 00-00	spout	1	10
4	90 28 10 161 00 90	set	1	2
5	90 15 05 064 02 90	cartridge	1	2
6	09 14 10 190 90	seal	1	2
7	09 28 30 030-00	cover	1	10
8	09 20 89 020-00	handle	1	10
9	09 31 11 063 90	pin	1	2
10	90 31 20 087 00-00	plug	1	10
11	04 30 04 101 00 90	hose	2	2
12	04 28 20 067 00 90	pipe	1	2
13	09 14 10 036 90	seal	1	2
14	04 30 11 040 00 90	fixing set	1	2
15	09 20 93 056 90	insert	1	2
16	90 24 03 253 00 90	adaptor	1	2
17	09 30 03 038 90	hose	1	2
18	04 21 50 010 00 90	accessories	1	2
19	09 30 09 031 90	key	1	60